

公差等级表 (以小数点位数)

长度 Length		角度 Angle	
X.	±1.5	X.°	±1°
X.X	±0.5	X.X°	±0.5°
X.XX	±0.20	X.XX°	±0.10°
X.XXX	±0.100		

电机参数 DATA LIST

额定电压	Rated Input	220	V AC
额定功率	Rated Output	400	W
额定扭矩	Rated Torque	1.27	N.m
峰值扭矩	Peak Torque	3.81	N.m
额定电流	Rated Current	2.5	Arms
峰值电流	Peak Current	7.5	Arms
额定转速	Rated Speed	3000	RPM
峰值转速	Peak Speed	6000	RPM
扭矩系数	Torque Constant	0.5±10%	N.m/Arms
反电势常数	Voltage Constant	31±10%	V/KRPM
线-线电阻	L-L Resistance	3.4±10%	Ω
线-线电感	L-L Induction	5.8±10%	mH
转动惯量	Rotor Inertia	0.53±10%	Kg.m ² ×10 ⁴
极对数	Poles pair	5	Pair
反馈元件	Feedback	17bit	Incremental
电机防护等级	IP	IP67 (Except connector and shaft seal)	
保持制动扭矩	Brake torque	无/No	N.m
制动器电压	Brake voltage	无/No	DC
绝缘等级	Isolation Class	F	
绝缘电阻	Isolation Resistance	>200MΩ DC500V	
旋转方向	Rotation Direction	Counterclockwise rotation (CCW) viewed from motor shaft end	
电机重量	Weight	Kg	
使用温度	Working Temperature	-20°C~50°C	
储存温度	Storage Humidity	20%-80%不结霜 20%-80%No condensation	
使用环境	Use Environment	远离活性气体、可燃气体、油、灰 Keep away from active gas, combustible gas, oil and ash	
安装海拔	Installation Altitude	1000m以下使用, 1000m以上降额使用 Below 1000m Be downshifted above 1000m	
测试条件	Test Conditions	安装在200*200*20厚的铝板上 Fixed on 200*200*20aluminum plate	
线缆规格	Cable Specification	4*0.75mm ² +2p*0.2mm ² 高柔性拖链电缆, 折弯次数不小于500万次 4 * 0.75mm ² +2p*0.2mm ² high flexible drag chain cable, with bending times not less than 500million times	

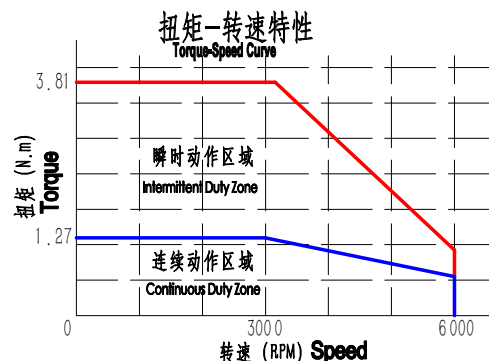
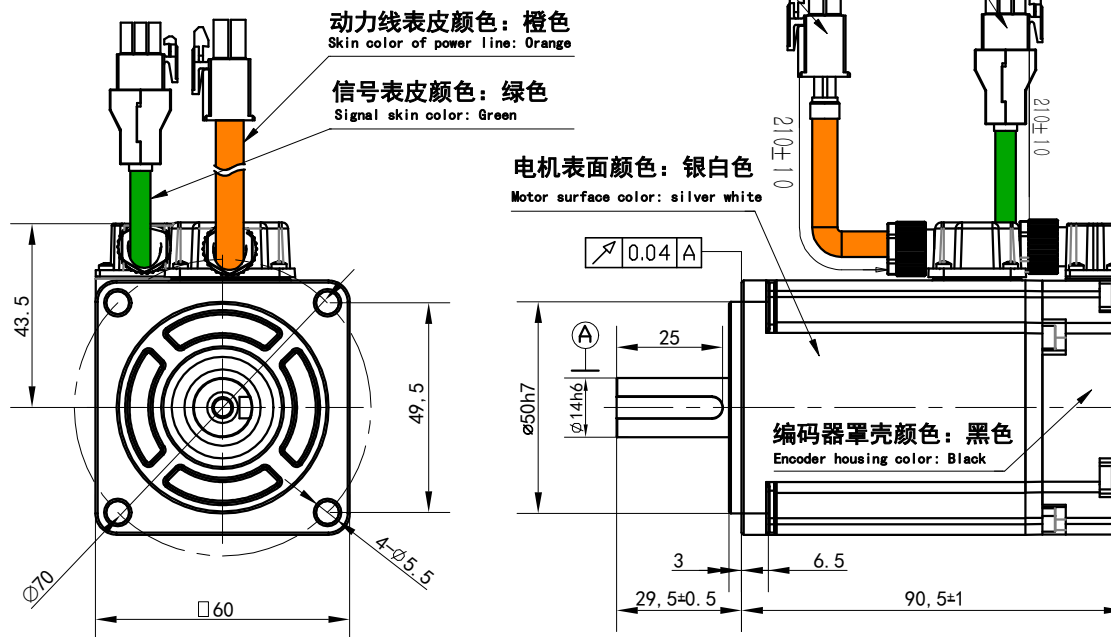

轴端剖面 A-A
Shaft end section

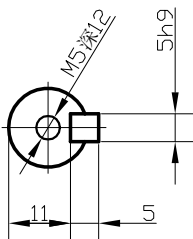

平键长度
Flat key length

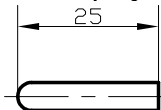

视图方向
View direction

1. 动力线连接器
1. Power Connector

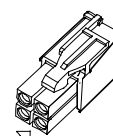

2. 编码器线连接器
2. Encoder Connector



视图方向
View direction

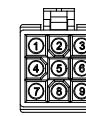
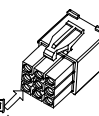

动力线及编码器线定义:

Definition of power line and encoder line:

位号 Tag number	信号 Signal	颜色 Color
1	U	红色 Red
2	V	白色 White
3	W	黑色 Black
4	PE	黄绿 Y/G
5	/	/
6	/	/

位号 Tag number	信号 Signal	颜色 (仅供参考) Color (For reference only)
1	FG	屏蔽线PE
2	+5V	红色 RED
3	OV (GND)	黑色 Black
4	E+	棕色 Brown
5	/	/
6	E-	白色 White
7	SD+	蓝色 Blue
8	/	/
9	SD-	黄色 Yellow

单位 Company	mm	机种 Type of Machine	60伺服电机 60 Servo Motor	R E V	A
比例 Proportion	1:1	图号 Drawing No	2022080501W		
图纸大小 Drawing Size	A4H	名称 Name	伺服电机规格书 Servo Motor Specification		
		物料编码 Material Code	1121100040101		
		型号 Model	ZE60MA1-0D40DQNM		
			中智电气南京有限公司 Chnchi Nanjing Electric Co., Ltd		
			项目 Project	设计 Design	日期 Date

项目 Project	设计单号 Design V No	修改内容 Modification content	审核 Check	日期 Date	设计 Design	日期 Date
△						
△						
△						
△						
1						